

Main Harness
PN: 115-0146-01

USB Port

To System Computer

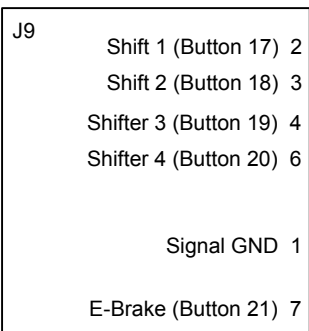
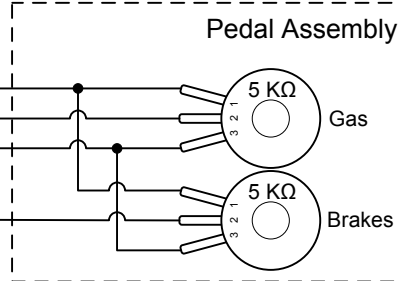
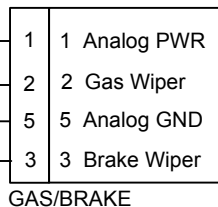
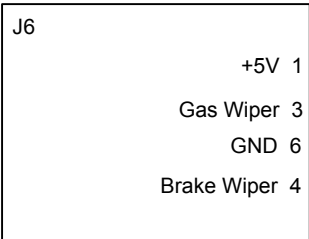

Chassis GND*

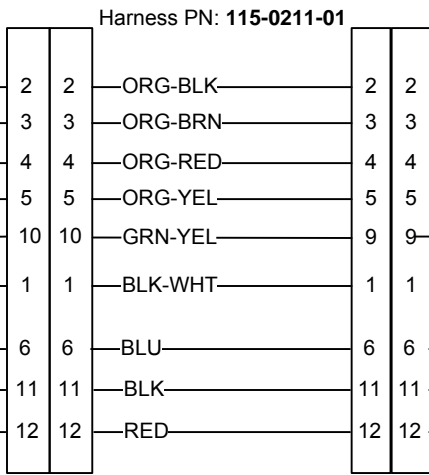

Harness PN: 115-0210-01

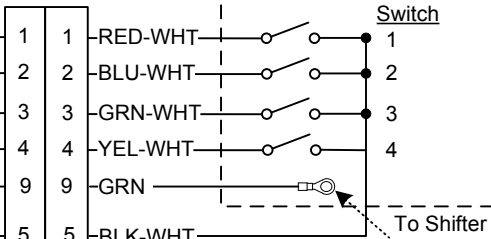

Micro Switch

To Shifter Chassis

E-Brake

E-Brake Lamp
5V, 0.2A (#555)

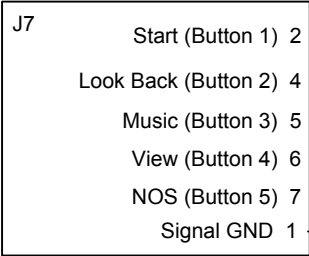
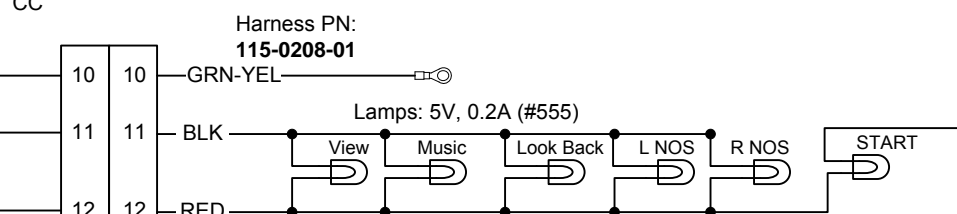
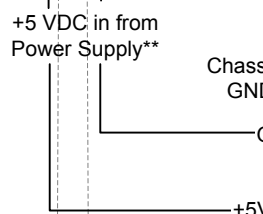
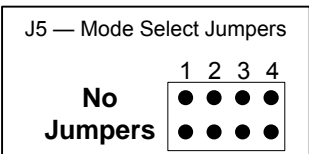

AA

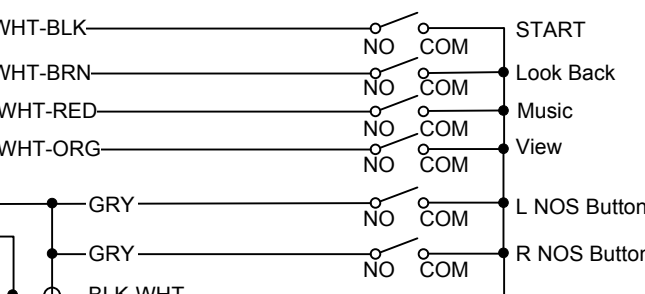

Harness PN: 115-0209-01

Harness PN: 115-0212-01

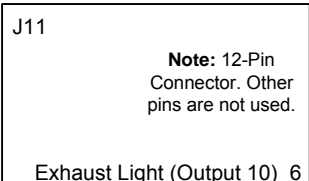
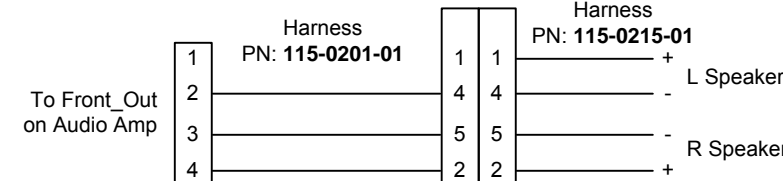
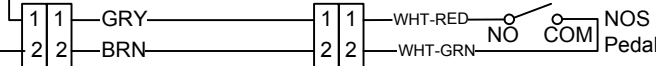

Note: 12-Pin Connector. Other pins are not used.

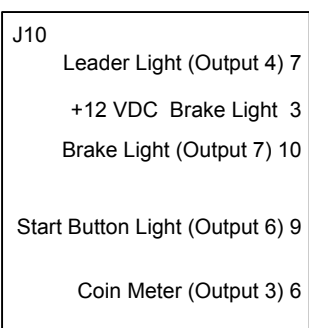
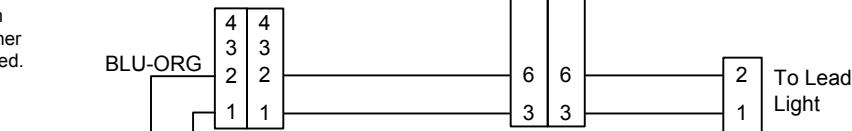

EE

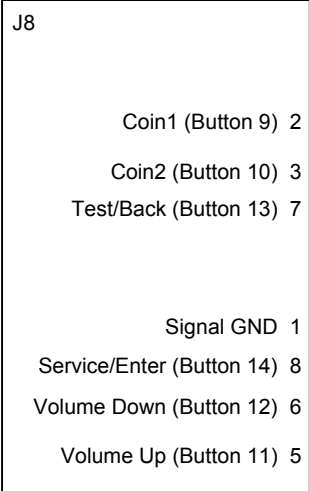
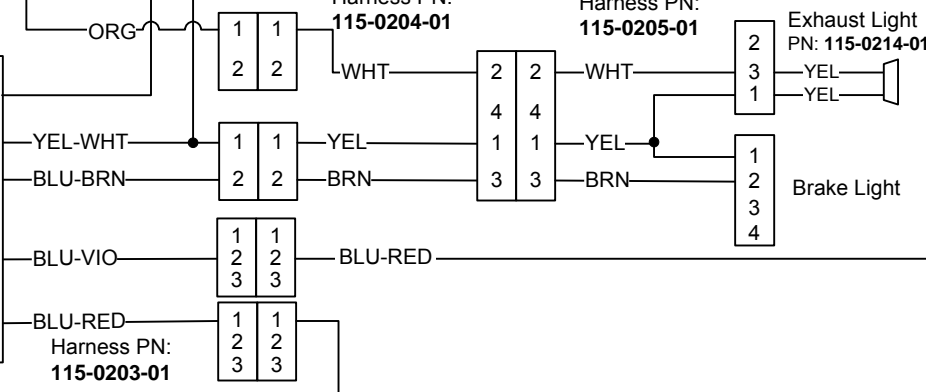

+5 VDC in from Power Supply**

Harness PN: 115-0152-01

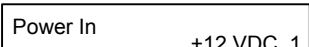
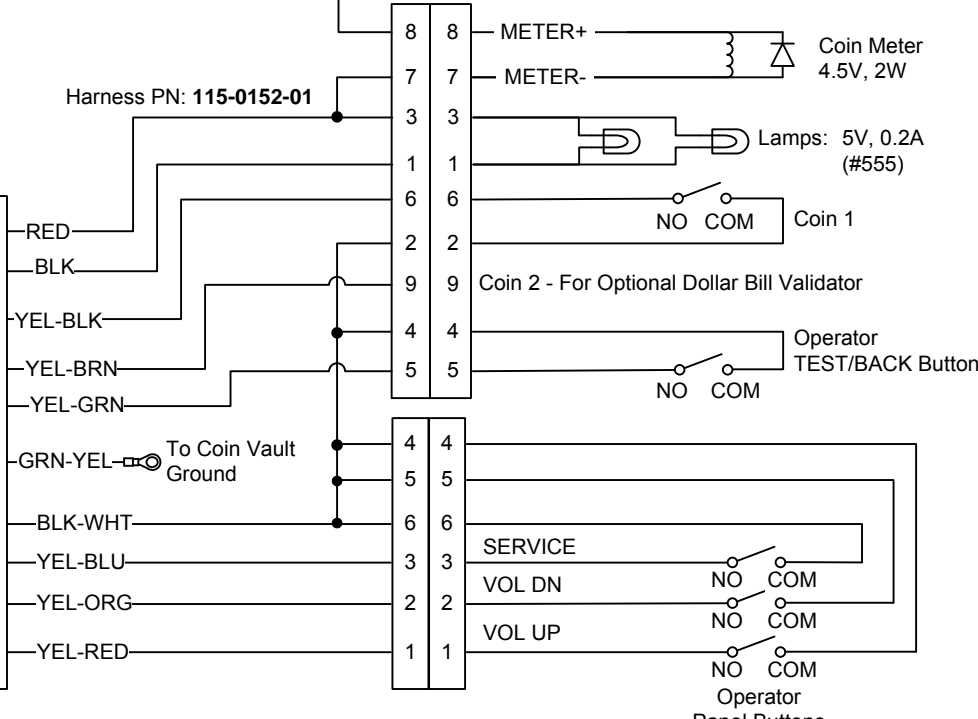

+12 VDC